

Planetary Gear Reducer for Servo Motor IB Series PE Type



《CAUTION》

- These Products should be handled, installed and maintained by trained technicians.
Carefully read the maintenance manual before use.
- This maintenance manual should be sent to the actual user.
- This maintenance manual should be kept by the user for future reference.

- Carefully read this maintenance manual and all accompanying documents before use (installation, operation, maintenance, inspection, etc.). Thoroughly understand the machine, information about safety, and all precautions for correct operation. Maintain this manual for future reference.
- Pay particular attention to the "DANGER" and "CAUTION" warnings regarding safety and proper use.



Improper handling may result in physical damage, serious personal injury and/or death.



Improper handling may result in physical damage and/or personal injury.

Matters described in  may lead to serious danger depending on the situation.

Be sure to observe important matters described herein.

DANGER

- Transport, installation, plumbing, wiring, operation, maintenance and inspections should be handled by properly trained technicians; otherwise, electric shock, injury, fire, or damage to the equipment may result.
- Consult our authorized service provider nearest to you if the product needs to be disassembled/reassembled or overhauled.
- When the unit is to be used in a system for transport of human beings, a protective device should be installed. There is a risk of personal injury or damage to the equipment due to runaway or falling.
- When the unit is to be used in an elevator, install a protective device on the elevator side to prevent it from falling; otherwise, personal injury, death, or damage to the equipment may result.

[Contents]

Contents	
[Introduction] Safety Precautions	1
[Contents]	2
[1] Inspection Upon Delivery	3
[2] Storage	5
[3] Transportation	6
[4] Installation	6
[5] Mounting the servo motor	8
[6] Coupling with Other Machines.....	10
[7] Operation	13
[8] Daily Inspection and Maintenance	15
[9] Troubleshooting	18
[10] Structural Drawing	19
[11] Warranty	20

⚠ CAUTION

- Unpack the unit after verifying that it is positioned right side up; otherwise, injury may result.
- Verify that the unit received is in fact the unit ordered. When a different unit is installed, injury or damage to the equipment may result.
- Do not remove the nameplate.

Upon delivery and receipt of the reducer check the following. If a nonconformity or problem is found, contact our nearest agent, distributor, or sales office.

- [1] Do the items on the nameplate conform to what was ordered?
- [2] Were there any parts that were broken during transport?
- [3] Are all bolts and nuts tightened firmly?

1-1 How to Refer to the Nameplate

When making an inquiry, advise us of the [1] Nomenclature and [2] Serial No.

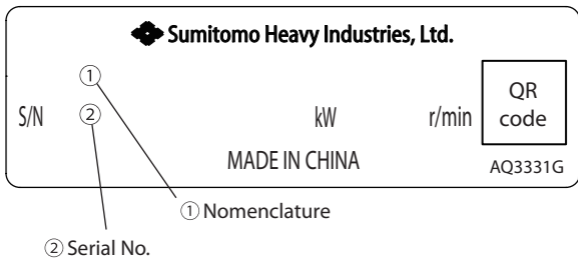

Figure 1-1 Nameplate

1-2 Lubrication Method

IB Series PE Type is a grease-lubricated unit. Grease is injected into the unit components before shipment so that no further lubrication is necessary during use.

[1] Inspection Upon Delivery

1-3 Nomenclature

The meanings of the symbols are as follows. Verify that the nomenclature matches that of the order.

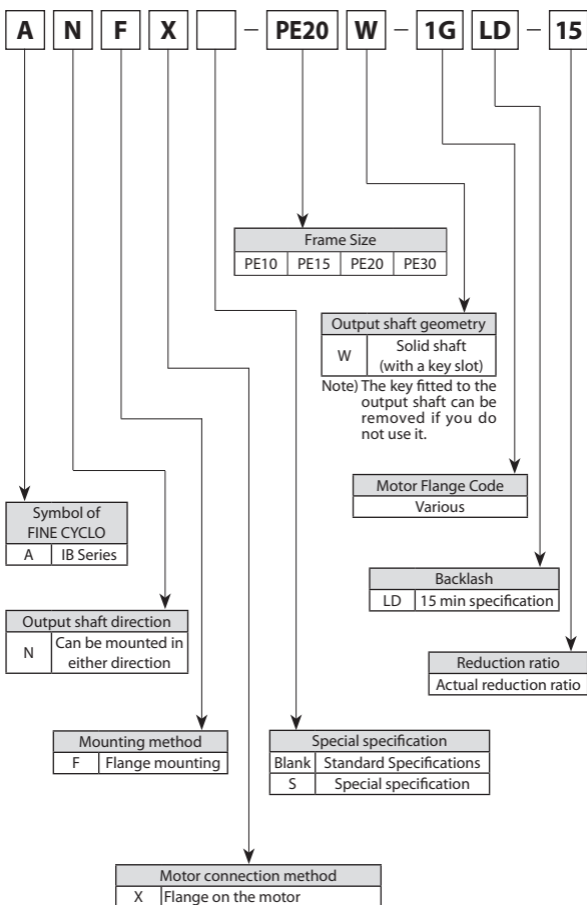

When storing reducers for any extended period of time, consider the following important points.

2-1 Storage Location

Store the unit indoors in a clean dry location.

Do NOT store the unit outdoors or in locations where there is excessive moisture, dust, severe temperature change, corrosive gas, etc.

2-2 Storage Period

- Storage period should be less than 1 year.
- Standard Rust Prevention Specifications

External rust proofing

Rustproofing oil is applied to the unit before shipment. After the unit is delivered, check the machined faces for rusting once every six months and reapply rustproofing or take other appropriate rust prevention steps as required.

Internal rustproofing

The product should be used in an environment free of severe moisture or dust, extreme temperature changes and corrosive gases. Storage should be provided under generally acceptable indoor manufacturing condition or in a warehouse.

- When the unit will be shipped overseas or stored for a period of longer than 1 year, please contact us for special rust prevention specifications.
- When the unit will be stored for a period of longer than 1 year, the unit should be operated for a few minutes under no-load conditions every two or three months.

2-3 Use After Storage

- The oil seal is prone to deterioration due to the surrounding conditions such as temperature, ultraviolet rays, etc., so after long-term storage, the unit should be inspected before operation, and any deteriorated parts should be replaced with new parts.
- When the storage period is 2 years or longer, the oil seals and grease should be replaced before starting operation.
- At the start of operation, make sure there is no abnormal noise, vibration, heat, etc. If any abnormal condition is observed, immediately contact our authorized service provider nearest to you.

[3] Transportation

 **DANGER**

- Do not stand directly under a unit suspended by a crane or other lifting mechanism; otherwise, injury or death may result.

 **CAUTION**

- Exercise ample care so as not to drop or tip over the unit during transportation.
- When lifting the unit using eye bolts in the threaded holes provided on the main unit, refer to the package, exterior drawings, catalog, etc., and do not lift a unit that is heavier than the rated load of the eye bolts; otherwise, the falling/tumbling of the unit or damage to the lifting devices may cause personal injury or equipment damage.
- After the unit has been mounted in the machine, avoid lifting the entire machine with using the eye bolts; otherwise, it may result in injury or damage to the equipment due to the unit falling or tipping over, or due to failure of the eye bolts.
- Use proper lifting fixtures, and make sure the eye bolts and nuts are not loose before lifting.

⚠ CAUTION

- Do not use the unit for a purpose other than that indicated on the nameplate or in the manufacturing specifications; otherwise, injury or damage to the equipment may result.
- Do not place any object that will hinder ventilation around the reducer; otherwise, the cooling effect is reduced, possibly leading to fire or burns due to excessive heat built-up.
- Absolutely do not stand on or hang from the unit; otherwise, injury or damage to the equipment may result.
- Do not touch the key slot at the end of the unit's shaft with bare hands. otherwise, injury may result.
- When the unit is used in food processing applications, machines for cleanroom and so on, vulnerable to oil contamination, install an oil pan or other such device to cope with grease leakage due to breakdown or failure; otherwise, grease leakage may cause failure of the unit, etc.

4-1 Place of Installation

Ambient temperature range

0 to 40°C (the unit may be unable to start up under some r.p.m. or torque condition when the temperature is very low. Consult us if the unit is going to be used at temperature levels close to 0°C).

Ambient humidity 85% or less. No condensation.

Altitude 1000m max.

Ambient atmosphere There should be no corrosive gas, combustible gas, or steam.

The location should be free from dust and well ventilated.

Installation location Indoor (free of severe dust and away from water or other liquid splashes)

- Mounting in conditions other than the above requires adherence to special specifications. Please consult with us.
- Mount in a location that enables easy operation, such as inspection and maintenance.
- Mount on a sufficiently rigid member.

4-2 Installation Angle

No limitation in the installation angle.

[5] Mounting the servo motor

5-1 Motor assembly procedure

The product has a special shaft coupling between the reducer gear and the motor so that a non-straight motor shaft such as key- or D-shape-cut shafts can be accommodated.

Assemble the motor in the following steps from (1) to (8):

(In the case of a key-slotted shaft, remove the key before assembly).

- (1) Wipe rustproofing or other oils from the motor shaft surface.
- (2) Place the reducer on an appropriate work surface with the coupling facing straight up.
- (3) Remove the plug from the setting hole .
- (4) Manually align the components so that the coupling tightening bolt can be tightened from the setting hole .
- (5) Insert the motor shaft into the center hole of the coupling . Press the shaft straight into the coupling, and engage the joint between the motor and the adapter plate .
- (6) Lock the motor and the adapter plate together by tightening the motor mounting bolt.
- (7) Tighten the coupling tightening bolt from the setting hole using a torque wrench. Tighten to the appropriate torque value shown on Table 5-1.
- (8) Reinstall the plug from the setting hole.

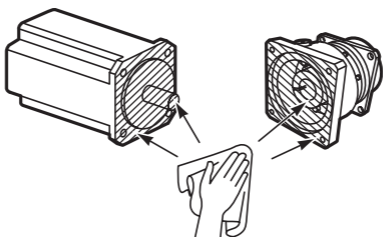

Table 5-1 Bolt tightening torque

Motor Flange Code	Coupling hole diameter mm	Tightening bolt	Tightening torque N·m
KA, KC, KD, 2D	8	M3	1.67
2H	9	M3	1.67
2J	10	M6	8.83
2L	11	M5	7.35
2P, 2R	14	M4	3.92
		M5	7.35
KH, 0V	14	M5	7.35
1G, 7B, 7S, 7V, KK, 7X	19	M6	8.83
1S, KQ	22	M8	21.6
1L, 8P	24	M6	8.83
7Z	24	M8	21.6
1T	28	M8	21.6
0X	35	M8	21.6

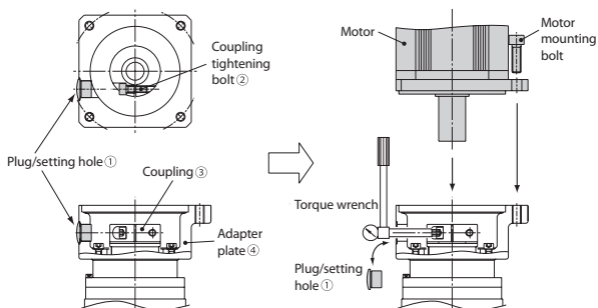

Figure 5-1 Assembly drawing

CAUTION

- Check the rotation direction before connecting the product to the driven machine. Connecting the product to an incorrect rotation direction may result in personal injury or equipment damage.
- When the product is to run on its own without being connected to other devices, remove the key from the output shaft in advance. Otherwise, the key may fly off the shaft and cause personal injury.
- Install a cover or other appropriate protection over the rotating parts to prevent human contact. otherwise, injury may result.
- When connecting the product to a load device, check alignment, belt tension and pulley parallelism for correct connection. In the case of direct coupling, carefully verify coupling accuracy. In the case of belt connection, correctly adjust belt tension. Before running the product, check that all the pulley/coupling tightening bolts are tight. Running the product with loose coupling may result in equipment damage due to fragments flying off the unit.

6-1 Checking the rotation direction

Verify that the rotation direction is the same as that of the input shaft.

6-2 Mounting a connecting element

When installing a connecting element, be careful not to impact the shaft or apply an excessive amount of thrust load. Bearing damage or collar disengagement may be caused.

Installation by shrink fit or shaft end thread engagement is recommended.

(1) When using a coupling

Make sure that the alignment errors (A, B and X) illustrated in Figure 6.1 are not greater than the specification values shown in Table 6-1.

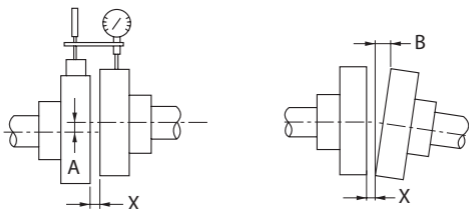

Figure 6-1

Table 6-1 Flexible coupling alignment errors

A size tolerance	0.1 mm or manufacturer-specified value
B side tolerance	0.1 mm or manufacturer-specified value
Dimension X	Manufacturer-specified value

[6] Coupling with Other Machines

(2) When using a chain/sprocket or gear coupling

In the case of chain-based coupling, make sure that the tensioned chain angle is at the right angle to the shaft.

Refer to the chain catalog or other appropriate information source to know the correct chain tension.

Make sure that the sprocket or gear pitch circle diameter is more than three times longer than the shaft diameter.

Have the sprocket or gear load action point positioned closer to this unit than the center of the shaft. (Refer to Figure 6-2).

(3) When using a timing belt

Excessively tensioning the timing belt may damage the shaft or bearing. Refer to the manufacturer's catalog or other appropriate information source to know the correct belt tension.

Refer to the manufacturer's catalog for the allowable values of parallelism and eccentricity (β) between pulleys. (Refer to Figure 6-3).

Have the timing belt load action point positioned as close as possible to this unit.

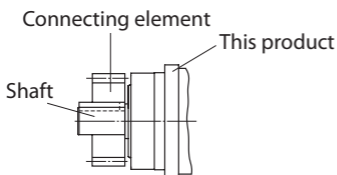

Figure 6-2

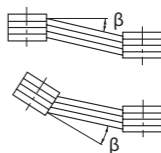

Figure 6-3

 **DANGER**

- Do not come close to or touch the rotating part (output shaft) while the unit is running. Entanglement may cause personal injury.

 **CAUTION**

- Do not put fingers or foreign object into the opening of the reducer; otherwise, injury or damage to the equipment may result.
- The reducer will become very hot during operation. Keep your hands and body away from the reducer. otherwise, burns may result.
- Stop the unit immediately when any abnormal condition is observed. Personal injury may be caused.
- Do not run the unit in excess of its rated load level. otherwise, injury or damage to the equipment may result.

7-1 Preparational checks

After installation is completed, check and confirm the following before running the unit:

- The unit is correctly connected to the driven machine.
- All the installation bolts are tight.
- The rotation direction is as planned.

Run the unit after the above checks are completed, first without load to break it in and then with a progressively increasing amount of load. Carry out the checks specified in Table 7-1 while the unit is running.

7-2 Check During Operation

Table 7-1 Check items during operation

Is there any abnormal noise or vibration?	Is the case deformed due to the installation surface not being completely flat? Is resonance observed due to the installation surface not being sufficiently rigid? • Does the center axis of the driven machine match? • Is vibration of the driven machine transmitted to the reducer?
Is the surface temperature abnormally high?	• Is the ambient temperature at the place of usage high?

If any abnormal condition is observed, immediately stop the unit and contact our authorized service provider nearest to you.

 **DANGER**

- Do not come close to or touch the rotating parts (output shaft etc.) while the unit is running. otherwise, loose clothing caught in these rotating parts may result in injury or death.

 **CAUTION**

- Do not put fingers or foreign object into the opening of the reducer; otherwise, injury or damage to the equipment may result.
- The reducer will become very hot during operation. Do not touch the unit with bare hands; otherwise, burns may result.
- Identify and provide appropriate corrective action in a timely fashion and according to this maintenance manual if any abnormal operating characteristics are observed. Do not operate the unit corrective action has been taken.
- Do not use damaged reducers; otherwise, injury or damage to the equipment may result.
- We can not assume any responsibility for damage or injury as a result of an unauthorized modification by a customer.
- Dispose of the reducer as general industrial waste.

[8] Daily Inspection and Maintenance

8-1 Daily Inspection

To ensure proper and continued optimum operation, use table 1 to perform daily inspections. All of the answers should be "No."

Table 8-1 Daily Inspection

Inspection Item	Details of Inspection
Noise	Is there abnormal sound? Is there sudden change in sound?
Vibration	Is vibration abnormally large? Does vibration change suddenly?
Surface temperature	Is the surface temperature abnormally high? Does the surface temperature rise suddenly?
Grease leakage	Is grease leaking from the gears? Is there any rust on the sliding surface of the oil seal?
Installation bolts	Is any installation bolt loose?
Chain Timing belt	Is the chain or timing belt loose?

- If any abnormal condition is observed during the daily inspection, remedy the situation by referring to 9, "Troubleshooting" (page 18). If the abnormal condition still persists, contact our authorized service provider nearest to you.

8-2 Maintenance of Main Unit

- Oil seals have a life, and after long-term use there may be a decrease in the seal effect due to natural deterioration and wear. Although the seal life greatly differs depending on the operating conditions and surrounding environment of the reducer, it is recommended that the seal be replaced every 1 to 3 years.

If the sliding surface of the oil seal becomes worn or rusted, replace the seal with a new one.

The unit's sliding surfaces are carbon steel. Any exposed part of the oil seal sliding surface must periodically receive rust prevention treatment such as rustproofing oil application so that rusting will not progress on the sliding surface.

8-3 Backlash

The product has been assembled with a preconditioned backlash. A complete backlash reconditioning would be necessary if the product is disassembled. Do not disassemble the product.

[9] Troubleshooting

If any abnormal condition is observed in or related to this unit, promptly remedy the situation by referring to Table 9-1. If the abnormal condition still persists, contact our local subsidiary nearest to you.

Table 9-1 Troubleshooting

Condition		Possible causes	Control
The motor runs when without load, but the output shaft does not turn		Unit damaged due to gear overloading etc.	Contact our local subsidiary
The motor runs with the output shaft turning when without load but when load is applied	Cannot run fast and becomes overheated	Unit overloaded	Reduce the load to the specification level
	Stops	The key is not fitted	Fit the key
		Bearing is burned	Contact our local subsidiary
	Runs in the reverse direction	Control setup error	Change the control setup
The unit becomes excessively heated		Unit overloaded	Reduce the load to the specification level
		Ambient temperature at the use location is too high	Improve ventilation
		Bearing damaged	Contact our local subsidiary
		Reduction gears excessively worn due to overloading etc.	Contact our local subsidiary
Grease leaking	Small amounts of grease seeping out or drooling from input or output shaft seals	Grease applied to the oil seals tends to seep out from the seals at the beginning of use	Wipe the grease off the oil seals and observe the condition
	Input or output shaft area Grease leakage	Oil seal or shaft damaged	Contact our local subsidiary
	Grease leaking from case joints or other mating faces	Tightening bolt loose	Contact our local subsidiary
Abnormal noise Abnormally severe vibration		Debris or foreign objects inside the bearing, or the bearing is damaged	Contact our local subsidiary
		Foreign objects stuck between reduction gears	Contact our local subsidiary
		Reduction gears damaged	Contact our local subsidiary
		Case deformed due to the installation surface not being completely flat	Correct the installation surface to make it completely flat or use liners etc. for adjustment
		Resonance due to the installation surface not being sufficiently rigid	Reinforce the installation surface for greater rigidity
		Shaft misalignment with the driven machine	Align the shafts
		Vibration of the driven machine transmitted to the reducer	Run the reducer on its own to locate the noise source

10-1 Structure drawing

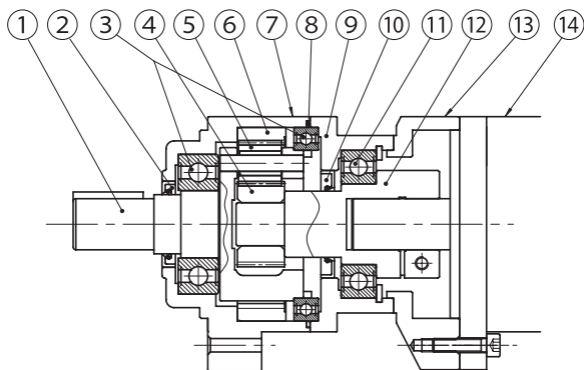

Figure 10-1 Single-reduction type (example: ANFX-PE15W)

Table 10-1 Main components

Part number	Description	Part number	Description
1	output flange	8	O-ring
2	Oil seal	9	Joint cover
3	Main bearing	10	Oil seal
4	Sun gear	11	Input shaft bearing
5	Planetary gear	12	coupling
6	Internal gear	13	adapter plate
7	Case	14	Motor (provided by the user)

[11] Warranty

The scope of warranty of our delivered products is limited only to what we manufactured.

Warranty (period and contents)

Warranty Period	The warranty period for the Products shall be 18 months after the commencement of delivery or 18 months after the shipment of the Products from the seller's works or 12 months from the Products coming into operation, whichever comes first.
Warranty Condition	In the event that any problem or damage to the Product arises during the "Warranty Period" from defects in the Product whenever the Product is properly installed and combined with the Buyer's equipment or machines, maintained as specified in the maintenance manual, and properly operated under the conditions described in the catalog or as otherwise agree upon in writing between the Seller and the Buyer or its customers; the Seller will provide, at its sole discretion, appropriate repair or replacement of the Product without charge at a designated facility, except as stipulated in the "Warranty Exclusions" as described below. However, if the Product is installed or integrated into the Buyer's equipment or machines, the Seller shall not reimburse the cost of: removal or re-installation of the Product or other incidental costs related thereto, any lost opportunity, any profit loss or other incidental or consequential losses or damages incurred by the Buyer or its customers.
Warranty Exclusions	Notwithstanding the above warranty, the warranty as set forth herein shall not apply to any problem or damage to the Product that is caused by: <ol style="list-style-type: none">1. installation, connection, combination or integration of the Product in or to the other equipment or machine that is rendered by any person or entity other than the Seller;2. insufficient maintenance or improper operation by the Buyer or its customers, such that the Product is not maintained in accordance with the maintenance manual provided or designated by the Seller;3. improper use or operation of the Product by the Buyer or its customers that is not informed to the Seller, including, without limitation, the Buyer's or its customers, operation of the Product not in conformity with the specifications, or use of lubricating oil in the Product that is not recommended by the Seller;4. any problem or damage on any equipment or machine to which the Product is installed, connected or combined or on any specifications particular to the Buyer or its customers;5. any changes, modifications, improvements or alterations to the Product or those functions that are rendered on the Product by any person or entity other than the Seller;6. any parts in the Product that are supplied or designated by the Buyer or its customers;7. earthquake, fire, flood, sea-breeze, gas, thunder, acts of God or any other reasons beyond the control of the Seller;8. normal wear and tear, or deterioration of the Products, parts, such as bearings, oil-seals;9. any other troubles, problems or damage to the Product that are not attributable to the Seller.

Worldwide Locations

North America / South America

Sumitomo Machinery Corporation of America (SMA)

4200 Holland Blvd. Chesapeake, VA 23323, U.S.A.

TEL (1)757-485-3355 FAX (1)757-485-7490

SM Cyclo of Canada, Ltd. (SMC)

1453 Cornwall Road, Oakville, Canada ON L6J 7T5

TEL (1)905-469-1050 FAX (1)905-469-1055

Europe

Sumitomo (SHI) Cyclo Drive Germany GmbH (SCG)

Cyclostraße 92, 85229 Markt Indersdorf, Germany

TEL (49)8136-66-0 FAX (49)8136-5771

India

Sumi-Cyclo Drive India Private Limited (SDI)

Gat No. 186, Rasoni Industrial Park, Alandi Markal Road, Fulgaon-Pune, Maharashtra, India

TEL (91)96-0774-5353

Southeast Asia / Oceania

Sumitomo (SHI) Cyclo Drive Asia Pacific Pte. Ltd. (SCA)

15 Kwong Min Road, Singapore 628718

TEL (65)6591-7800 FAX (65)6863-4238

China

Sumitomo (SHI) Cyclo Drive China, Ltd. (SCT)

11F, SMEG Plaza, No. 1386 Hongqiao Road, Changning District, Shanghai, China (P.C. 200336)

TEL (86)21-3462-7877 FAX (86)21-3462-7922

Taiwan

Tatung SM-Cyclo Co., Ltd. (TSC)

22 Chungshan N. Road 3rd., Sec. Taipei, Taiwan 104, R.O.C.

TEL (886)2-2595-7275 FAX (886)2-2595-5594

Korea

Sumitomo (SHI) Cyclo Drive Korea, Ltd. (SCK)

Royal Bldg. 19 Rm. 913, 5 Saemunan-ro 5-Gil Jongro-Gu Seoul, Korea 03173

TEL (82)2-730-0151 FAX (82)2-730-0156

Japan

Sumitomo Heavy Industries, Ltd. (SHI)

ThinkPark Tower, 1-1 Osaki 2-chome, Shinagawa-ku, Tokyo 141-6025, Japan

TEL (81)3-6737-2511 FAX (81)3-6866-5160

Specifications, dimensions, and other items are subject to change without prior notice.



Sumitomo Heavy Industries, Ltd.

Power Transmission & Controls Group

Headquarter ThinkPark Tower, 1-1 Osaki 2-chome,
Shinagawa-ku, Tokyo 141-6025, Japan

No.ZM1001E-2.0

EK10 Printed 2019.10